

Zappatrici

Rotary tillers
Fraises rotatives
Bodenfräsen
Rotocultivadores



La Gamma

Disponibili per trattori da 15 a 250 cv

GB Available for tractors from 15 up to 250 hp

F Disponibles pour tracteurs de 15 à 250 cv

D Verfügbar für Traktoren von 15 bis 250 PS

E Disponibles para tractores de 15 a 250 hp

GB The range F La gamme D Die Auswahl E La gama

Zappatrici rotative spostabili

GB SIDE SHIFT ROTARY TILLERS F FRAISES ROTATIVES DÉPORTABLES D BODENFRÄSEN MIT SEITLICHER VERSCHIEBUNG E ROTOCULTIVADORES CON DESPLAZAMIENTO



Zappatrici rotative idrauliche

GB SIDE SHIFT ROTARY TILLERS F FRAISES ROTATIVES DÉPORTABLES D BODENFRÄSEN MIT SEITLICHER VERSCHIEBUNG E ROTOCULTIVADORES CON DESPLAZAMIENTO



Zappatrici rotative fisse

GB ROTARY TILLERS F FRAISES ROTATIVES D BODENFRÄSEN E ROTOCULTIVADORES



La Gamma

Disponibili per trattori da 15 a 250 cv

GB Available for tractors from 15 up to 250 hp

F Disponibles pour tracteurs de 15 à 250 cv

D Verfügbar für Traktoren von 15 bis 250 PS

E Disponibles para tractores de 15 a 250 hp

GB The range F La gamme D Die Auswahl E La gama



B 60 PL
(30-70 HP) cm 130-155-185-205



B 83
(50-90 HP) cm 155-180-205-230



B 170V
(70-170 HP) cm 250-280-300



B 250V
(100-200 HP) cm 250-300



B 103
(50-100 HP) cm 155-185-205-230-250



B 123
(60-120 HP) cm 205-230-250-280-300

Zappatrice rotativa pieghevole

GB FOLDING ROTARY TILLER F FRAISE ROTATIVE REPLIABLE D BODENFRÄSEN KLAPPBAR E ROTOCULTIVADORE PLEGABLE



DOBLE
(150 - 250 HP) Cm. 360 - 400 - 460 - 500

TRASMISSIONE LATERALE

GB SIDE TRANSMISSION F TRANSMISSION LATÉRALE D SEITLICHES GETRIEBE E TRASMISSION LATERAL

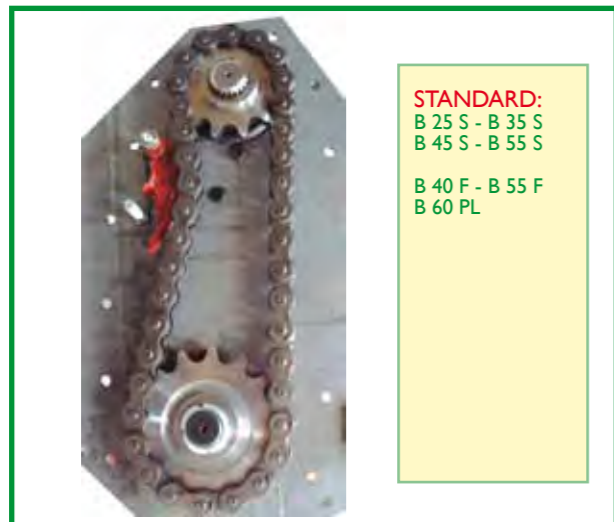

STANDARD:
B 25 S - B 35 S
B 45 S - B 55 S

B 40 F - B 55 F
B 60 PL

Catena con tedi catena
GB Cain with automatic tensioner
F Chaîne avec tendeur
D Ketten mit automatischer stellenschraube
E Cadena con tensore automatico

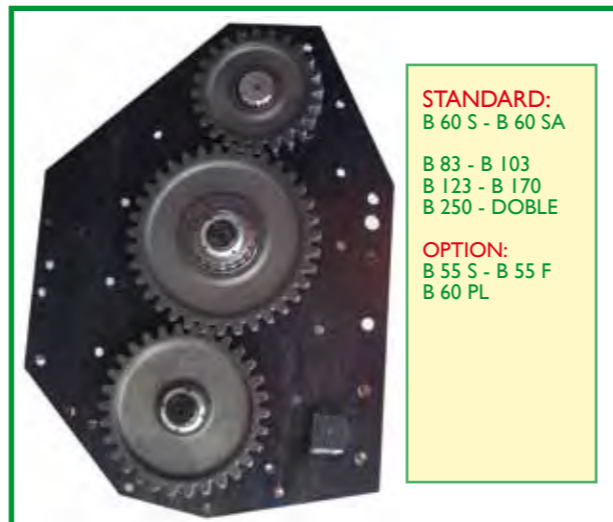

STANDARD:
B 60 S - B 60 SA

B 83 - B 103
B 123 - B 170
B 250 - DOBLE

OPTION:
B 55 S - B 55 F
B 60 PL

Ingranaggi
GB Gears
F Pignons
D Zahnradantrieb
E Piñones

CAMBIO VELOCITÀ

GB GEARBOX F BOÎTIER D GETRIEBE E CAJA ENGRANAJES

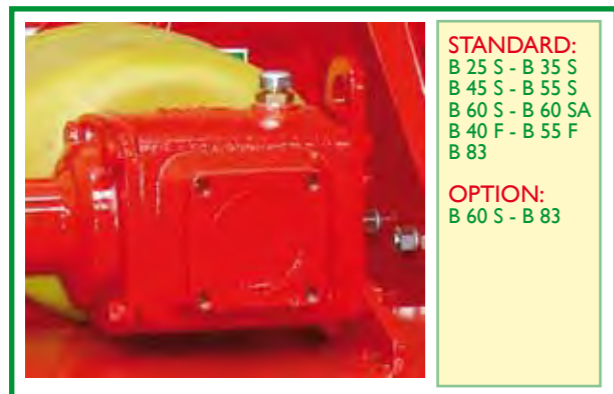

STANDARD:
B 25 S - B 35 S
B 45 S - B 55 S
B 60 S - B 60 SA
B 40 F - B 55 F
B 83

OPTION:
B 60 S - B 83

Scatola cambio I velocità
GB Single speed gearbox
F Boîtier monovitesse
D Einganggetriebe
E Caja engr. I velocidad

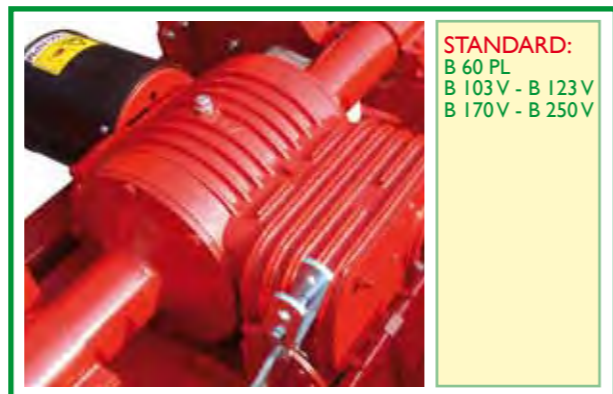

STANDARD:
B 60 PL
B 103V - B 123V
B 170V - B 250V

Scatola cambio multi velocità
GB Multi speed gearbox
F Boîtier de vitesses
D Wechselrad getriebe
E Caja de velocidades



Doble: scatola cambio I velocità
GB Single speed gearbox
F Boîtier monovitesse
D Einganggetriebe
E Caja engr. I velocidad



REGOLAZIONE PROFONDITÀ DI LAVORO

GB WORKING DEPTH ADJUSTMENT F RÉGLAGE PROFONDEUR DE TRAVAIL D ARBEITSTIEFE E REGULACIÓN PROFUNDIDAD DE TRABAJO

SLITTE

GB Skids F Patins D Kufen E Patines



STANDARD:
B 25 S - B 35 S
B 45 S - B 55 S
B 40 F - B 55 F
B 60 PL - B 83
B 103 - B 123
B 170V - B 125V



STANDARD:
B 60 S - B 60 SA



STANDARD:
DOBLE

Con catena
GB With chain
F Avec chaîne
D Mitt kette
E Con cadena

RULLI POSTERIORI

GB Rollers F Rouleaux D Walzen E Rodillos



OPTION:
B 60 PL Ø 477
B 83 Ø 477
B 103 Ø 477
B 123 Ø 477
B 170V Ø 525
B 250V Ø 526



OPTION:
B 60 PL Ø 405
B 83 Ø 405
B 103 Ø 405
B 123 Ø 405
B 170V Ø 450
B 250V Ø 450
DOBLE Ø 450



OPTION:
B 103 Ø 406
B 123 Ø 464
B 170V Ø 464
B 250V Ø 500
DOBLE Ø 464

COFANI POSTERIORI

GB REAR HOOD F CAPOT ARRIÈRE RÉGABLE D HAUBE E CAPÓ TRASERO



STANDARD:
B 25 S
B 35 S
B 45 S
B 55 S
B 40 F
B 55 F
B 103
B 123



STANDARD:
B 60 PL
B 83
B 170V
B 250V
DOBLE

Con molle
GB With springs
F Avec ressorts
D Mitt feder
E Con resortes

SPOSTAMENTO LATERALE MECCANICO O IDRAULICO

GB MECHANICAL OR HYDRAULIC SIDE SHIFT F DÉPORT LATÉRAL MÉCANIQUE OU HYDRAULIQUE
D MECANISCHE ODER HYDRAULISCHE SEITENVERSCHIEBUNG E DESPLAZAMIENTO LATERAL MECANICO O HIDRAULICO



STANDARD:
B 25 S / B 35 S / B 45 S / B 55 S



STANDARD: HYDRAULIC
B 60 S



STANDARD: HYDRAULIC and AUTOMATIC
B 60 SA

ATTACCHI POSTERIORI SPOSTABILI

GB SIDE SHIFT LOWER LINKAGES F ATTELAGES INFÉRIEURS DÉPORTABLES
D NIEDRIGE ANBAUBOCKE E ENGANCHES INFERIORES DESPLAZABLES



STANDARD:
B 40 F / B 55 F / B 60 PL / B 83

ATTACCHI ANTERIORI OSCILLANTI

GB FRONT FLOATING HITCHES F ATTELAGES OSCILLANTS
D BEWEGLICHE TRAKTORANSCHLÜSSE E ENGANCHES DELANTEROS OSCILANTES



STANDARD:
B 103 / B 123 / B 170V / B 250V / DOBLE

ROTORI

GB ROTORS F ROTORS D ROTOREN E ROTORES



Disponibile per: GB Available on: F Disponible pour: D Vorhanden an: E Disponible por:

- 1 Tutta la gamma con zappette a virgola o squadra GB All the range with "C" or "L" blades F Toute la gamme avec lames coudées ou à equerre D Der ganze bereich mit bogenmesser oder winkelmesser E Toda la gamma con cuchillas a "C" o "L"
- 2 Mod. BK per: For - Pour - Für - Por B 170V - DOBLE
- 3 Mod. SPIKE per: For - Pour - Für - Por B 123 - B 170V - DOBLE
- 4 Mod. FLASH per: For - Pour - Für - Por B 83 - B 103 - B 123 - B 170V



OPTION:
Ø cm: 280 B 25 S - B 35 S
Ø cm: 280 B 45 S - B 55 S
Ø cm: 280 B 40 F - B 55 F
Ø cm: 280 B 60 PL - B 60 S
Ø cm: 280 B 60 SA - B 83



OPTION:
Ø cm: 320 B 103 - B 123
Ø cm: 320 B 170V - B 250V

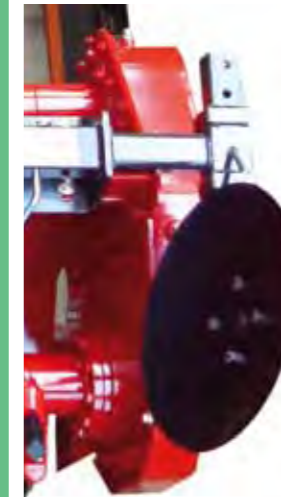

OPTION:
B 103 - B 123 - B 170V
B 250V - DOBLE



OPTION:
B 103 - B 123 - B 170V
B 250V - DOBLE



OPTION:
B 60 PL - B 60 S - B 60 SA
B 83 - B 103 - B 123
B 170V - B 250V
STANDARD: DOBLE



OPTION:
B 123 - B 170V - B 250V

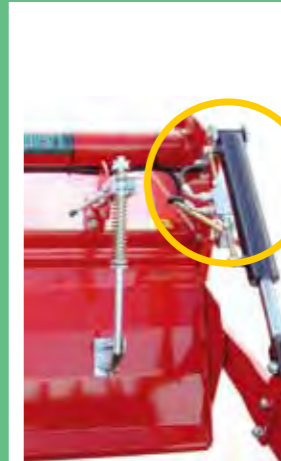

OPTION:
B 123 - B 170V - B 250V
STANDARD: DOBLE

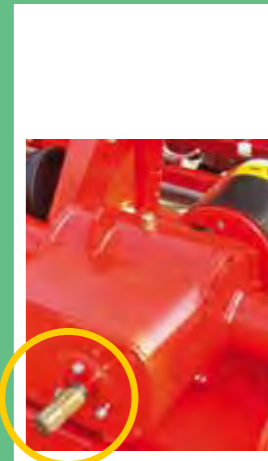

OPTION:
B 123
STANDARD: B 170 - B 250V

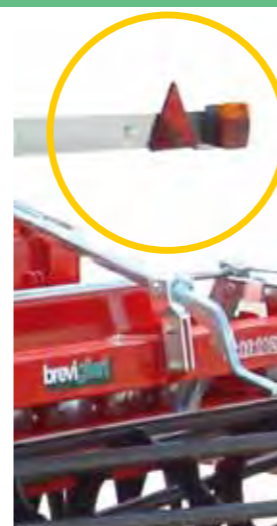

STANDARD: DOBLE



OPTION:
B 25 S - B 35 S - B 45 S
STANDARD: B 55 S - B 55 F
B 60 PL - B 60 S
B 60 SA - B 83
B 103



OPTION:
B 45 S - B 55 S - B 40 F
B 55 F - B 60 PL - B 60 S
B 60 SA - B 83 - B 103
STANDARD: B 123
B 170V
B 250V



OPTION:
B 60 PL - B 60 S - B 60 SA
B 83 - B 103 - B 123
B 170V - B 250V
STANDARD: DOBLE

MOD.								
	RPM	RPM	HP	Kg.	Cm.	Cm.	N.	Cm.
B40F 85	540	230	15-20	130	82	99	16	5-15
B40F 105	540	230	15-25	160	102	144	20	5-15
B40F 125	540	230	20-30	190	122	139	24	5-15
B40F 145	540	230	25-35	220	142	162	28	5-15
B40F 155	540	230	30-40	230	152	165	32	5-15
B55F 125	540	230	25-35	245	125	144	36	5-15
B55F 145	540	230	30-45	265	145	164	42	5-15
B55F 165	540	230	35-50	290	165	184	48	5-15
B55F 185	540	230	35-60	322	185	204	54	5-15
B60PL 130	540	188 210 263 294	30-45	320 450 440	130	164	30	5-15
B60PL 155	540	188 210 263 294	35-50	355 480 470	155	184	36	5-15
B60PL 185	540	188 210 263 294	45-60	400 510 500	185	204	42	5-15
B60PL 205	540	188 210 263 294	55-70	435 540 530	205	224	48	5-15
B83 155	540	242	50-60	440 580 560	155	170	42	10-20
B83 180	540	242	50-70	470 620 600	180	195	48	10-20
B83 205	540	242	60-80	510 660 640	205	220	54	10-20
B83 230	540	242	70-90	550 700 680	230	245	60	10-20
B103 155	540	169 238 301	50-70	620 710 790 810	155	170	36	10-25
B103 185	540	169 238 301	50-70	620 710 790 810	185	200	42	10-25
B103 205	540	169 238 301	60-75	650 750 820 860	205	220	48	10-25
B103 230	540	169 238 301	70-80	680 790 890 910	230	245	54	10-25
B103 250	540	169 238 301	75-100	710 840 920 970	250	265	60	10-25
B123 205	540 1000	214 240 302 293 374	60-70	750	205	220	48	10-25
B123 230	540 1000	214 240 302 293 374	60-90	800 970 1000 1100	230	245	54	10-25
B123 255	540 1000	214 240 302 293 374	70-100	850 1020 1050 1150	255	265	60	10-25
B123 280	540 1000	214 240 302 293 374	80-110	900 1070 1100 1200	280	295	66	10-25
B123 300	540 1000	214 240 302 293 374	90-120	950 1120 1150 1250	300	315	72	10-25
B170V 250	1000	244 303 338	70-120	940 1080 1080 1240	250	270	60	10-20
B170V 280	1000	244 303 338	90-140	1020 1160 1160 1330	280	300	66	10-20
B170V 300	1000	244 303 338	100-170	1100 1240 1240 1420	300	320	72	10-20
B250V 250	1000	207 230 286	100-140	1160 1200 1240 1440	250	275	60	10-20
B250V 300	1000	207 230 286	170-200	1320 1360 1400 1600	300	325	72	10-20

X: con cofano with hood avec capot mit haube con tapa

MOD.								
	RPM	RPM	HP	Kg.	Cm.	Cm.	N.	Cm.
B25S 85	540	184	10-20	145	85	97	16	5-15
B25S 105	540	184	15-25	160	105	117	20	5-15
B25S 125	540	184	20-30	175	125	137	24	5-15
B35S 105	540	231	15-25	160	105	117	20	5-15
B35S 125	540	231	20-30	175	125	137	24	5-15
B35S 145	540	231	25-35	190	145	157	28	5-15
B45S 125	540	226	20-30	225	125	138	24	5-15
B45S 145	540	226	30-40	235	145	158	28	5-15
B45S 165	540	226	30-50	245	165	178	32	5-15
B55S 145	540	273	25-35	275	145	163	28	5-15
B55S 165	540	273	30-50	295	165	183	32	5-15
B55S 185	540	273	35-60	315	185	203	36	5-15

Vi: vigneto vineyard vignes weinbau viña
Fr: frutteto orchard verger obstbau huerto
Fr.L: frutteto larga grand verger obstbau breit huerto ancha

MOD.								
	RPM	RPM	HP	Kg.	Cm.	Cm.	N.	Cm.
B60S 130	540	210	25-45	410 405	130	149	30	5-15
B60S 155	540	210	35-50	440 435 430	155	174	36	5-15
B60S 185	540	210	45-60	470 465 460	185	204	42	5-15
B60S 205	540	210	55-70	500 495 490	205	224	48	5-15
B60SA 130	540	210	25-45	430 420	130	149	30	5-15
B60SA 155	540	210	35-60	460 455 460	155	174	36	5-15
B60SA 185	540	210	40-70	500 500 500	185	204	42	5-15
B60SA 205	540	210	55-70	540 540 540	205	224	48	5-15

MOD.								
	RPM	RPM	HP	Kg.	Cm.	Cm.	N.	Cm.
DOBLE 360	1000	258	150-200	2040 2390 2620	360	252	84	10-20
DOBLE 400	1000	258	180-220	2155 2500 2740	400	252	96	10-20
DOBLE 460	1000	258	200-230	2310 2655 2895	460	252	108	10-20
DOBLE 500	1000	258	220-250	2400 2760 3055	500	252	120	10-20

X: con cofano with hood avec capot mit haube con tapa

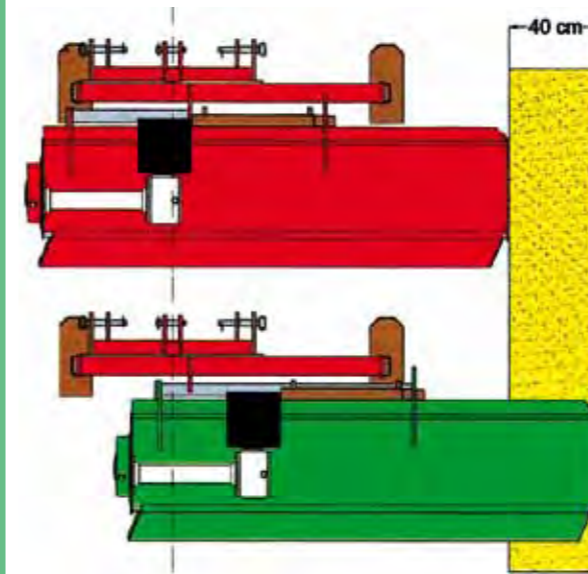

b60s/sa 130	Vi.		67
b60s/sa 130	Fr.		107
b60s/sa 155	Vi.		82
b60s/sa 155	Fr.		122
b60s/sa 155	Fr. L		142
b60s/sa 155	Fr. L		152
b60s/sa 155	Vi.		92
b60s/sa 155	Fr.		132
b60s/sa 155	Fr. L		122
b60s/sa 155	Fr. L		162
b60s/sa 155	Fr. L		142
b60s/sa 155	Fr. L		182
b60s/sa 155	Vi.		102
b60s/sa 155	Fr.		142
b60s/sa 155	Fr.		132
b60s/sa 155	Fr. L		172
b60s/sa 155	Fr. L		152
b60s/sa 155	Fr. L		192

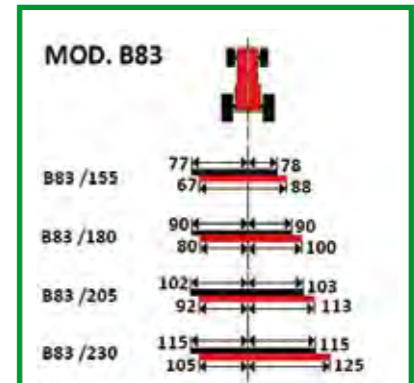
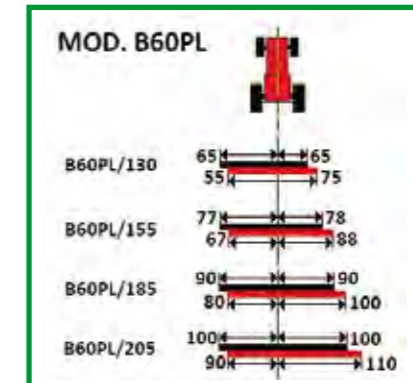
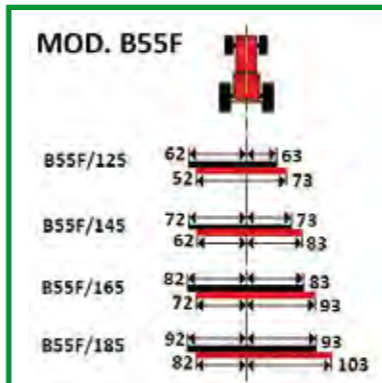
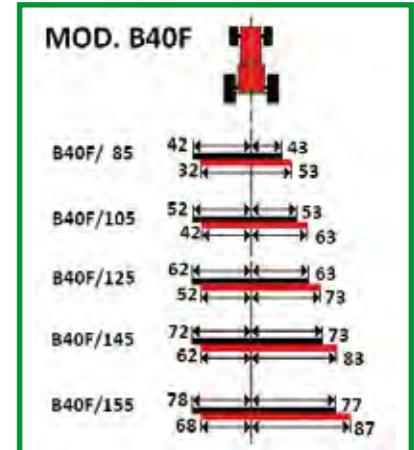
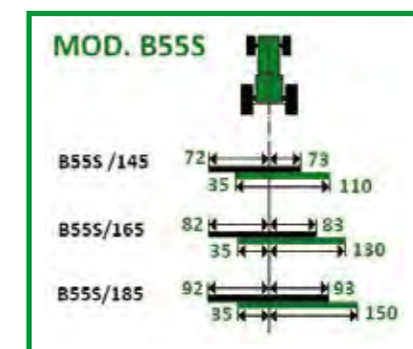
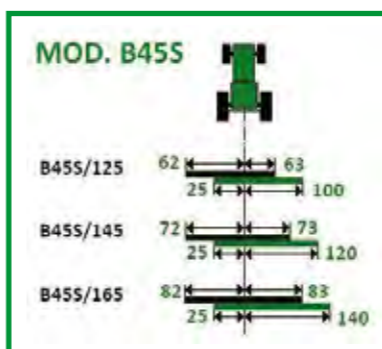
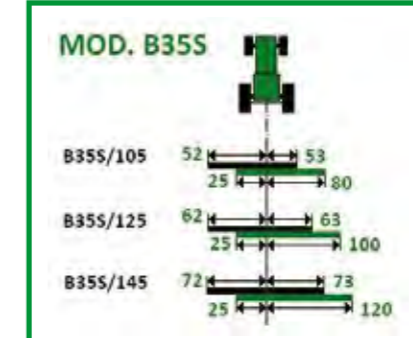
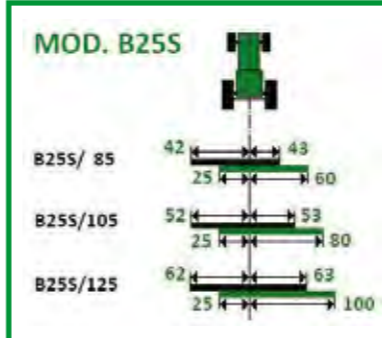



 **breviglieri**



Sur la Forêt, 16 -5340 SOREE (Belgique)
+32/83/67.72.33 - info@monfortsa.be
www.monfortsa.be



Monfort SA



monfort.sa.soree