

NEW



## SKID STEER AND COMPACT TRACK LOADER

155/175/210/215/250/270/300/330/150T/210T/215T/250T/270T/300T/320T/325T

Operating weight: 2,955 – 5,089 kg Gross rated power: 42 – 55 kW (56 – 74 hp)



## THE RANGE.

### INTRODUCING THE LATEST RANGE OF JCB SKID STEER AND COMPACT TRACK LOADERS.

With 16 small or large platform models to choose from featuring both vertical lift and radial lift options on wheeled and tracked chassis' and with engines from 42kW (56hp) to 55kW (74hp), there's sure to be a model to suit your needs.

With their unique Powerboom™ design and side entry door, JCB skid steers and compact track loaders are both stronger and safer than conventional twin arm machines but still give you all the power and performance you need.





# STRENGTH AND DURABILITY.

JCB HAS EARNED ITS REPUTATION FOR STRENGTH AND DURABILITY, AND JCB SKID STEER AND COMPACT TRACK LOADERS ARE BUILT TOUGH TO HANDLE THE DEMANDS OF ANY APPLICATION AND ANY CONDITION.

## Structural strength.

**1** Fully-welded chassis provides a rigid structure for maximum strength and reduced weight. For consistent performance on demanding terrain, JCB skid steer and compact track loaders feature a solid undercarriage with cast steel, triple-flanged rollers.

**2** JCB rams utilise the keyhole casting design for structural strength and durability.

**3** A large chassis cross-member provides maximum strength to further support the Powerboom™, with either a standard mechanical quick hitch or the optional powered variant.

**4** Wheeled models feature durable, forged steel axles and a strengthened drive chain for trouble free operation in all conditions.

**5** The fuel tank is mounted inside the loader tower for maximum protection, and is equipped with an easily accessible drain port. The optional fuel cap protection plate prevents debris from gathering around the neck of the cap.

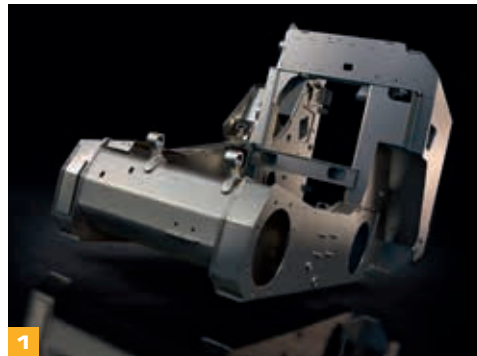

## Built to last.

- 6** The iconic JCB Powerboom™ boasts tapered pivot pins and 20 percent more steel than conventional twin-arm skid steer designs. The result is greater rigidity for less wear, longer life and improved retention of material in the bucket.
- 7** The JCB Powerboom™ provides safe internal routing for hydraulic hoses, for maximum protection from impact and other damage.
- 8** The quick hitch comprises high-tensile steel and high-strength welds for longer life, and features a fully-closed tilt cylinder to eliminate debris infiltration on large platform models.
- 9** For extra support and greater breakout force, JCB skid steers have the largest quick hitch pivot pins in the industry, and increased pivot pin diameter on the boom.
- 10** JCB's stringent test programs include prolonged high-stress loading of the chassis, boom and other key components, as well as cold climate testing and repeated transmission use over thousands of cycles.



## POWER AND PERFORMANCE.

WITH PLENTY OF POWER AND VERSATILE FEATURES, JCB SETS NEW STANDARDS FOR EFFICIENCY AND PRODUCTIVITY IN SKID STEER AND COMPACT TRACK LOADERS.

### Versed in versatility.

**1** Unlike conventional skid steer cooling systems, the JCB engine cooling system pulls cool, clean air from above and forces hot air out through the sides and rear, away from the operator. The result is improved, efficient cooling, even in extreme conditions.

**2** An industry standard quick hitch provides quick and efficient coupling not only for all JCB attachments, but for any brand of skid steer attachments on the market.

**3** The standard hydraulic circuit on JCB small-platform skid steer and compact track loaders has a flow rate of 70 lpm. For large platform machines, the standard hydraulic circuit flow rate is 90 lpm. A high-flow option, up to 125 lpm (depending on machine size), is available for maximum attachment versatility.

**4** Optional counterweight packages are available on some models, for increased rated operating capacity (ROC), to meet individual requirements.



## Maximum output.

**5** The 300 and 300T models feature variable displacement piston pump hydraulics for faster cycle times and smoother multi-functioning.

**7** Optional parallel lift makes it easier to position loads with forks or attachments on all JCB models. Parallel lift helps to keep loads level throughout the lift cycle; ideal for carrying palletised loads.

**6** JCB's optional Smoothride System (SRS) allows the boom and load to move independently from the chassis, for improved load retention, operator comfort and, ultimately, faster loading cycles and journey times.

**8** The JCB minimal footprint of the JCB skid steer and compact track loader range, combined with 360-degree pivot capability, allows for easy manoeuvring within confined job sites.

Vertical lift capability provides maximum lift capacity at maximum height and reach, making it the right choice for load and carry operations, including fork work, heavy construction and landscaping.

Radial lift capability provides improved digging geometry. This is the preferred choice for operating attachments, but also used for jobs such as backfilling, excavating, grading applications, asphalt work, and street construction.

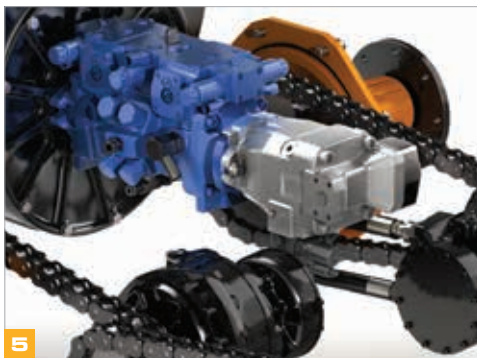
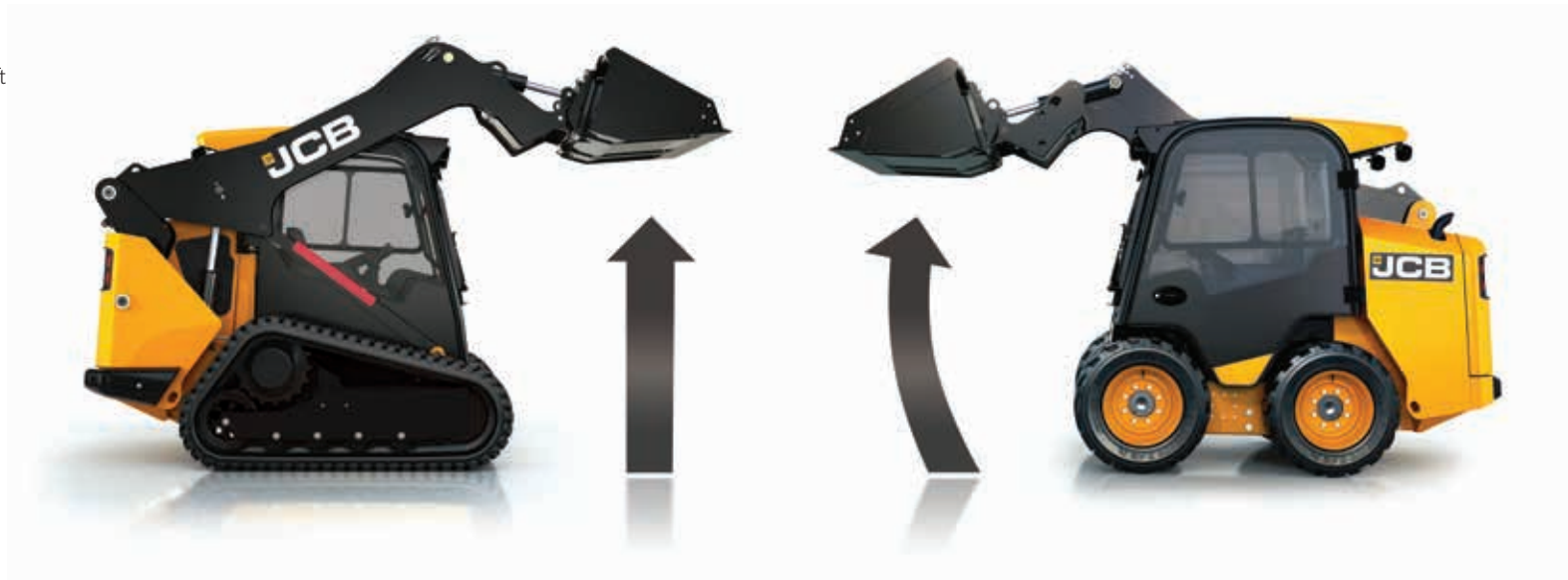

# THE WORLD'S SAFEST.

WITH A WIDE-OPENING SIDE DOOR FOR SAFE ENTRY AND EXIT, WITH A JCB MACHINE OPERATORS NO LONGER NEED TO CLIMB OVER LARGE ATTACHMENTS OR UNDER AN UNSUPPORTED BOOM.

## All around visibility.

**1** Thanks to JCB's Powerboom™ loader arm, operators of JCB skid steer and compact track loaders enjoy 60 percent better visibility around the machine than users of conventional twin-arm machines.

**2** The low boom profile on hi-viz models allows excellent visibility to both sides of the machine, the quick hitch, as well as enhanced visibility to the tracks or wheels.

**3** Flat glass is easy and cost effective to replace if necessary. A mesh option is also available to suit specific applications.

The side-mounted windshield wiper on all models with a fully enclosed cab improves front visibility to the quick hitch and attachment for increased productivity.

**4** With no requirement for the rear torque tube found on conventional machines, operators of JCB vertical lift models benefit from even greater rear visibility. Additionally a standard-fit rear view mirror enhances rearward visibility.

Traditional Twin Arm Skid Steer and Track Loaders

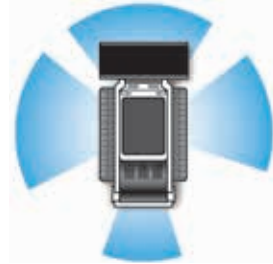

165° All-round Visibility

JCB Skid Steer and Track Loaders



270° All-round Visibility





### Safer by design.

**7** A wide-opening door and large grab handles enable easy and safe entry and exit, eliminating crush and slip hazards associated with front-entry skid steers and compact track loaders.

**8** Emergency exit from JCB skid steer and compact track loaders is via the front of the machine, as opposed to the small rear window on conventional twin-arm designs.

A reverse alarm is standard, and a white noise reverse alarm is available as an option.

**9** An optional beacon and front screen guard are available for increased safety and security. Other options include a fire extinguisher and a variety of tyre choices.

An optional keyless immobiliser allows the operator to enter a four-digit PIN to start the machine, instead of a keyed ignition.

**10** The optional electric quick hitch is fitted with a single-point lock-and-unlock flag for optimal visibility, to ensure that the attachment is safely locked/unlocked.

**11** Tasks such as loading a truck or changing attachments are simplified due to excellent visibility to the cutting edge of the bucket and quick hitch.

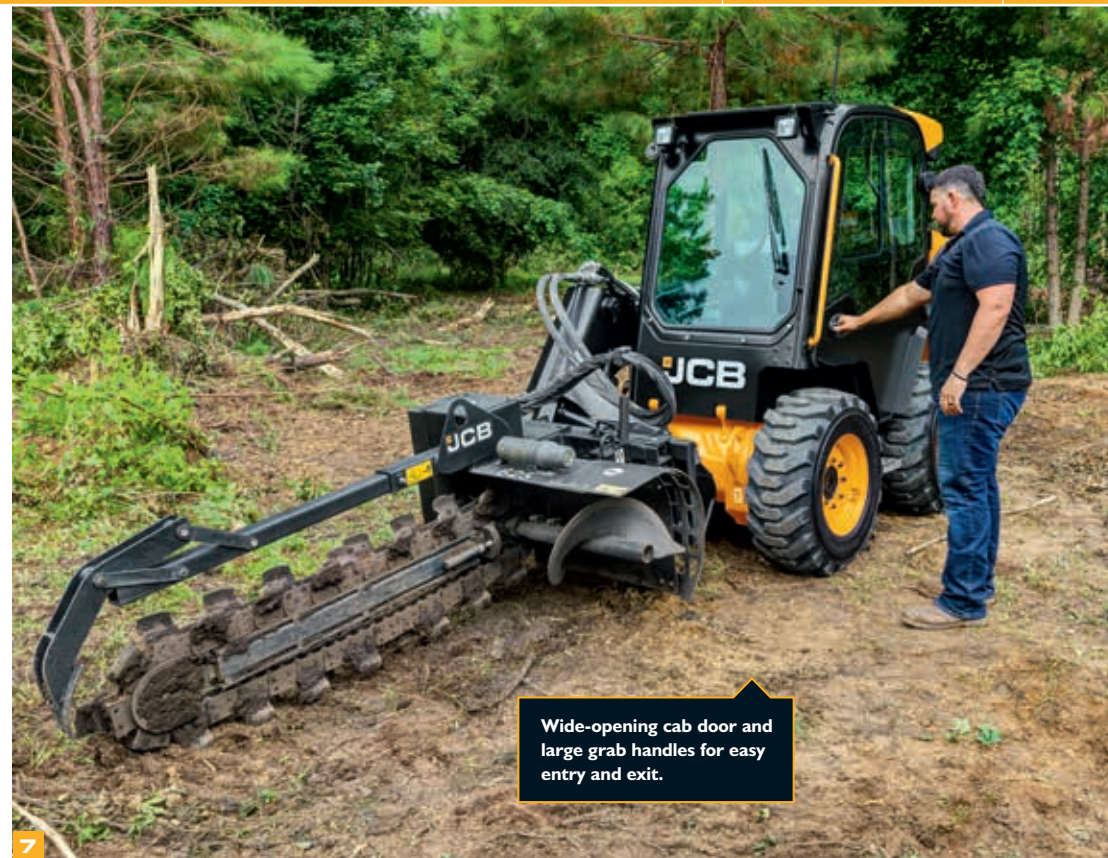

7

Wide-opening cab door and large grab handles for easy entry and exit.



8



9



10



11

## TOTAL COMFORT AND CONTROL.

WITH EASY SIDE-DOOR ENTRY, THE LARGEST CABS ON THE MARKET, ELECTRIC CONTROLS AND ADJUSTABLE JOYSTICK CONTROLS, JCB SKID STEERS AND COMPACT TRACK LOADERS OFFER UNRIVALLED COMFORT FOR MAXIMUM PRODUCTIVITY.

### Industry-leading operator environment.

**1** The latest JCB cab is in a class of its own for ergonomics and operator comfort. The operator environment on large-platform JCB machines is 33 percent larger than the competition; on small platform machines, JCB cabs are 46 percent bigger.

**2** JCB cabs feature a handy storage space and 12-volt power socket for charging mobile phones and other devices.

**3** JCB skid steers and compact track loaders have one of the best ventilation systems in the industry, thanks to three cab ventilation filters and an external panel cover. Air conditioning is available as an option, to provide the perfect, controllable cabin environment.

Deflection plates in the engine bay direct heat out of the rear door and away from the operator.

**4** All JCB skid steer and compact track loader cabs are fitted with a sliding window on the left side for improved ventilation and communication with co-workers.



### Total control.

5 JCB's myCHOICE control software allows the responsiveness of the joysticks to be adjusted. Three settings allow operators to tailor the sensitivity of joystick movement to match the way they work. The new software enables one-touch unlock operation for ease of use.

6 Instrumentation at operator eye-level on the left side of the cab includes the integrated standard radio and climate control functions. This position limits exposure to dirt and dust to avoid damage.

7 On the right side of the cab, an easily accessible control panel features machine diagnostics, electric hand throttle and ignition switch.

8 ISO or H-pattern controls are available to suit operator preferences. ISO (single joystick operation) comes as the standard control pattern but the ISO-H Pattern option can be added.

9 The diagnostics, electronic throttle and ignition switch are within easy reach, minimising fatigue. An optional 7-way multi-function joystick (included with high-flow hydraulics option) makes it easy to control a wider range of attachments.

The radio features an AUX port that is compatible with mobile phones and other devices.

Operators can control power, torque and tractive effort; allowing for maximum productivity.



5



6



7



8



9

## A SOUND INVESTMENT.

JCB SKID STEERS AND COMPACT TRACK LOADERS ARE EFFICIENT TO USE, OWN AND OPERATE. SUPERIOR BUILD QUALITY, GREAT FUEL EFFICIENCY AND LOW RUNNING COSTS ENSURE HIGH RESALE VALUES AND MAXIMUM RETURN ON INVESTMENT.

### JCB EcoMAX.

**1** Our T4 Final EcoMAX engine uses up to 9% less fuel than our Tier 3 units, saving you money.

EcoMAX produces its peak torque at low revs for fuel-efficient matching of the transmission and hydraulics.

Because this engine doesn't require costly exhaust after-treatment or heat-resistant lube oils, it saves money on servicing.

EcoMAX can be remapped to operate on low quality fuels. This means these loaders can be resold across different territories, improving residuals.

### JCB Diesel by Kohler.

**2** Small platform JCB skid steers and compact track loaders are equipped with the JCB Diesel by Kohler KDI Tier-4 Final engine, featuring a maintenance-free diesel oxidation catalyst (DOC) and offering improved torque and fuel efficiency.

JCB Diesel by Kohler engines boast an advanced combustion system that significantly reduces emissions and fuel consumption.

Like the JCB EcoMAX unit, JCB Diesel by Kohler engines require no exhaust after-treatment, such as DEF or a DPF, for reduced operating costs and maintenance down time.



**More for your money.**

3 The hydraulic, variable speed cooling fan automatically responds to the engine speed; as RPMs increase or decrease, so too does fan speed, increasing productivity.

4 An optional, reversible fan purges debris from the rear screen, reducing maintenance downtime and increasing productivity in dirty, dusty conditions. Reverse airflow can be set to auto-mode, or engaged manually by the operator from inside the cab as required.

5 JCB large platform skid steer and compact track loaders are equipped with an air intake scavenge system as standard, minimising debris build-up in the air filter to extend service intervals.

A belly plate underneath the machine protects it from impact damage.

6 An optional 2-speed transmission enables JCB skid steers and compact track loaders to achieve faster travel and cycle times.



## SIMPLE SERVICING.

JCB SKID STEER AND COMPACT TRACK LOADERS ARE LOW-MAINTENANCE AND EASY TO SERVICE, MAKING THEM AFFORDABLE, EFFICIENT AND HIGHLY PRODUCTIVE.



### Unrivalled serviceability.

**1** All daily checks and greasing can be performed at ground level. Daily maintenance points, pre-filters, oil and air filters are easy to access via a large, rear service door. The door is recessed for protection from potential impact damage.

If access to major components is required, the cab can be tilted in less than five minutes.

**2** JCB's tilting cabs can be operated by one person and opened in just a few minutes, to provide access for more detailed maintenance. On large-platform models, this can be done without raising the boom.

**3** O-ring face seal hydraulic fittings reduce leaks and maintenance downtime.

To facilitate a quick clean out with a power washer, the engine bay is extremely accessible. Additionally, the machines also feature flat floors with no foot wells for speedy turnaround times.

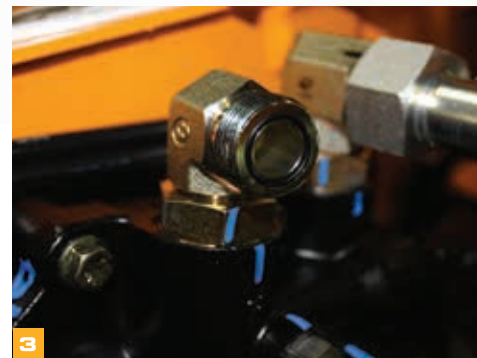

## VALUE ADDED.

JCB'S WORLDWIDE CUSTOMER SUPPORT IS FIRST CLASS. WHATEVER YOU NEED AND WHEREVER YOU ARE, WE'LL BE AVAILABLE QUICKLY AND EFFICIENTLY TO HELP MAKE SURE YOUR MACHINERY IS PERFORMING TO ITS FULL POTENTIAL.



1

1 Our Technical Support Service provides instant access to factory expertise, day or night, while our Finance and Insurance teams are always on hand to provide fast, flexible, competitive quotes.

2 The global network of JCB Parts Centres is another model of efficiency; with 16 regional bases, we can deliver around 95% of all parts anywhere in the world within 24 hours. Our genuine JCB parts are designed to work in perfect harmony with your machine for optimum performance and productivity.



2

3 JCB Assetcare offers comprehensive extended warranties and service agreements, as well as service-only or repair and maintenance contracts. Irrespective of what you opt for, our maintenance teams around the world charge competitive labour rates, and offer non-obligation quotations as well as fast, efficient insurance repair work.



3

Note: JCB LIVELINK and JCB ASSETCARE may not be available in your region, so please check with your local dealer.

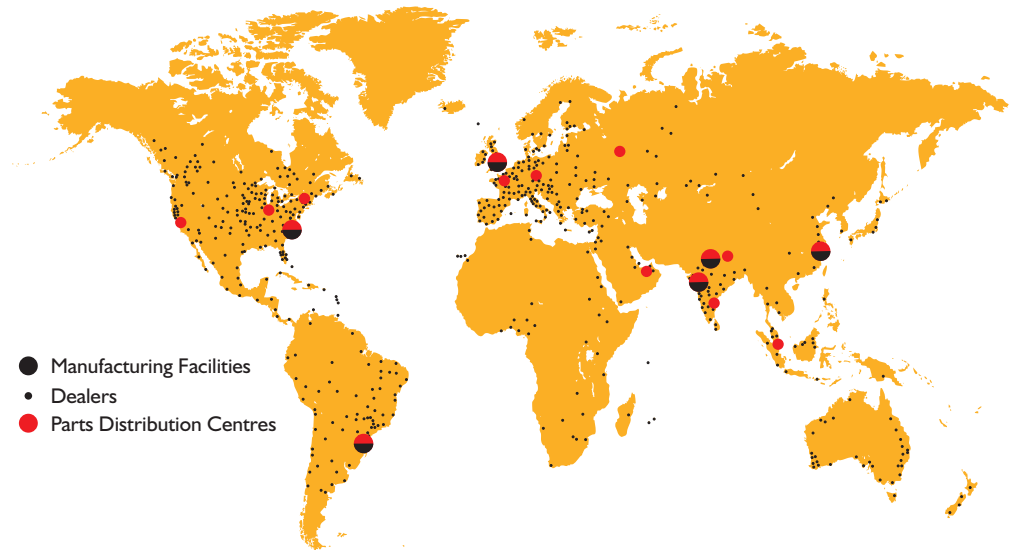

STATIC DIMENSIONS – SKID STEER LOADER

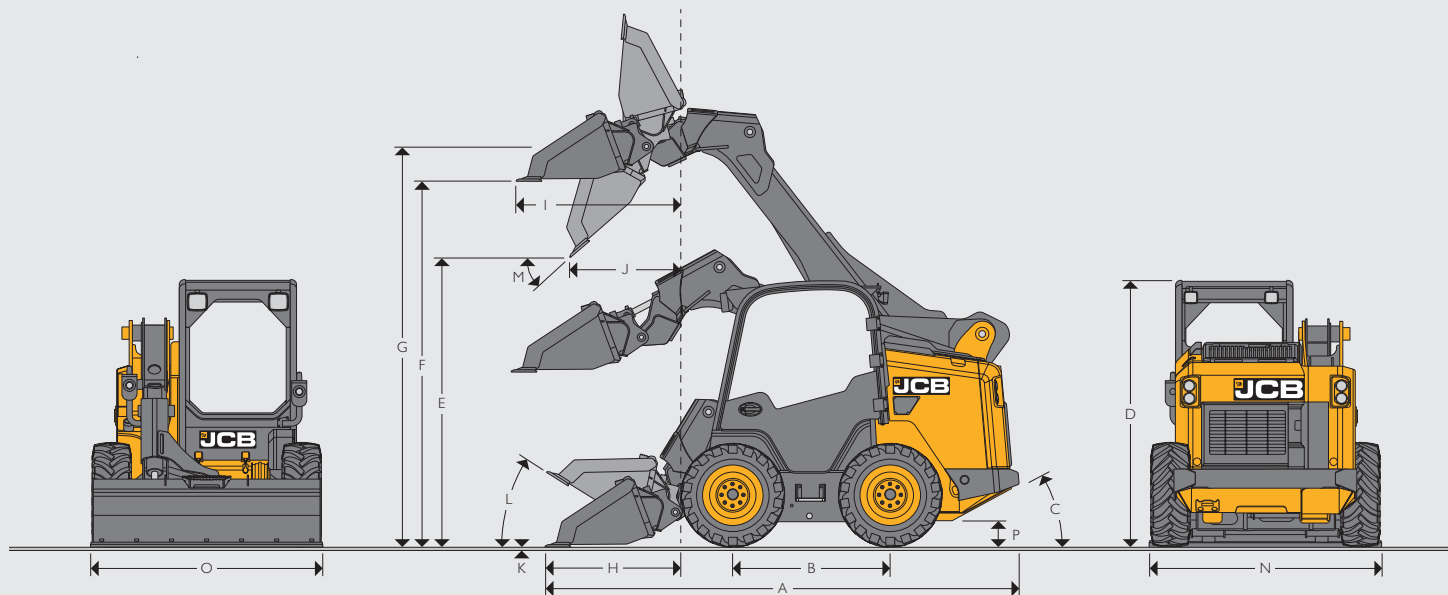

STATIC DIMENSIONS – SKID STEER LOADER

	SMALL PLATFORM				LARGE PLATFORM			
	Radial	Vertical	Radial	Vertical	Radial	Vertical	Vertical	Vertical
<b>Lift path</b>								
<b>Machine model</b>	<b>155</b>	<b>175</b>	<b>210</b>	<b>215</b>	<b>250</b>	<b>270</b>	<b>300</b>	<b>330</b>
A Overall length	m	3.49	3.49	3.49	3.49	3.80	3.80	3.80
B Wheelbase	m	1.07	1.07	1.07	1.07	1.25	1.25	1.25
C Angle of departure	degrees	25°	25°	25°	25°	29°	29°	29°
D Overall height	m	1.98	1.98	1.98	1.98	2.10	2.10	2.13
E Dump height	m	2.26	2.26	2.26	2.26	2.30	2.30	2.35
F Loadover height	m	2.84	2.84	2.84	2.84	2.90	2.90	2.93
G Pin height	m	3.00	3.00	3.00	3.00	3.20	3.20	3.23
H Reach @ ground level	m	1.00	1.00	1.00	1.00	1.10	1.10	1.08
I Max. reach @ full height	m	0.91	1.21	1.21	1.21	1.00	1.30	1.28
J Reach @ full height - fully dumped	m	0.56	0.86	0.56	0.86	0.60	0.90	0.88
K Dig depth clearance	m	-10	-10	-10	-10	-10	-10	-10
L Rollback @ ground	degrees	30°	30°	30°	30°	30°	30°	30°
M Dump angle	degrees	42°	42°	42°	42°	42°	42°	42°
N Width over tyres - standard	m	1.52	1.52	1.52	1.52	1.80	1.80	1.80
O Bucket width - standard	m	1.68	1.68	1.68	1.68	1.90	1.90	1.90
Bucket capacity - standard	m <sup>3</sup>	0.36	0.36	0.36	0.36	0.43	0.43	0.43
<b>Turning radius</b>								
Bucket corner radius	m	2.09	2.09	2.09	2.09	2.30	2.30	2.30
Quick hitch radius	m	1.14	1.14	1.14	1.14	1.50	1.50	1.50
Rear chassis radius	m	1.65	1.65	1.65	1.65	1.76	1.76	1.76
P Ground clearance	mm	210	210	210	210	250	250	250

300 (R17.5 Tyres)





## HYDRAULIC PERFORMANCE - SKID STEER

Machine model		SMALL PLATFORM				LARGE PLATFORM			
		155	175	210	215	250	270	300	330
SAE Cab operating weight (no counterweight)	kg	2955	3093	3123	3290	3726	3937	4213	4416
SAE Cab operating weight (1 pair suitcase weights)	kg	N/A	N/A	3166	3330	N/A	N/A	N/A	N/A
SAE Cab operating weight (2 pair suitcase weights)	kg	N/A	N/A	3209	3390	N/A	N/A	N/A	N/A
Rated operating capacity (ROC) 35% (no counterweight)	kg	492	557	671	670	803	865	1011	1046
Rated operating capacity (ROC) 50% (no counterweight)	kg	703	795	959	958	1146	1235	1445	1495
ROC with full counterweight	kg	N/A	N/A	1015	1024	N/A	N/A	N/A	N/A
Tipping load - no counterweight	kg	1406	1590	1918	1915	2293	2471	2889	2989
Tipping load - full counterweight	kg	N/A	N/A	2030	2049	N/A	N/A	N/A	N/A
Loader lift capacity with bucket	kgf	1770	1570	1874	2083	2669	2747	2747	2747
Bucket tilt breakout force	kgf	1820	2140	1798	2222	2968	2968	2968	2968

## HYDRAULIC PERFORMANCE - COMPACT TRACK LOADER

Machine model		SMALL PLATFORM				LARGE PLATFORM			
		150T	210T	215T	250T	270T	300T	320T	325T
SAE Cab operating weight (no counterweight)	kg	3691	4021	4127	4818	4991	5089	5248	5608
SAE Cab operating weight (1 pair suitcase weights)	kg	N/A	4067	4173	N/A	N/A	N/A	N/A	N/A
SAE Cab operating weight (2 pair suitcase weights)	kg	N/A	4112	4219	N/A	N/A	N/A	N/A	N/A
Rated operating capacity (ROC) 35% (no counterweight)	kg	680	841	955	1146	1235	1361	1452	1452
Rated operating capacity (ROC) 50% (no counterweight)	kg	972	1202	1365	1751	1812	1957	2074	2074
ROC with full counterweight	kg	N/A	885	970	N/A	N/A	N/A	N/A	N/A
Tipping load - no counterweight	kg	1943	2403	2729	3502	3624	3913	4148	4148
Tipping load - full counterweight	kg	N/A	2529	2771	N/A	N/A	N/A	N/A	N/A
Loader lift capacity with bucket	kgf	1770	1869	2083	2528	2634	2634	2634	2634
Bucket tilt breakout force	kgf	1820	2010	2243	2968	2968	2968	2968	2968

## HYDRAULICS - SMALL PLATFORM AND LARGE PLATFORM

In addition to the main hydrostatic drive pumps, there is a dedicated service pump for the loader and attachments (auxiliary hydraulics circuit standard flow on all base models).

	155/175/150T/210/215/210T/215T	250/270/300/330/250T/270T/300T/320T/325T
<b>Standard flow</b>	70 liters/min @ 2,730 rpm engine speed Main relief pressure 3335 psi (230 bar) HYD Power Low Flow (36.0 hp)*	90 liters/min @ 2,300 rpm engine speed Main relief pressure 3335 psi (230 bar) HYD Power Low Flow (46.7 hp)*
<b>Optional auxiliary high flow</b>	155/175/150T 100 liters/min HYD Power High Flow (51.4 hp)*	250/270/250T/270T 120 liters/min HYD Power High Flow (61.7 hp)*
<b>Optional auxiliary high flow</b>	210/215/210T/215T 115 liters/min HYD Power High Flow (59.1 hp)*	300/330/300T/320T/325T 125 liters/min HYD Power High Flow (64.2 hp)*

- Low joystick lever efforts give excellent and easy control of transmission, loader and attachments.
- Auxiliary hydraulics are actuated on the joystick roller giving progressive control of hydraulic fluid flow for precise attachment control
- Loader arm hydraulic lines under protective steel guard on PowerBoom™.
- Canister style, full flow, hydraulic oil filter.
- JCB engine oil for engine and chain case.
- JCB hydraulic oil.

\*Calculated

## CAPACITIES

		SMALL PLATFORM	LARGE PLATFORM
Hydraulic system (including tank)	litres	43.5	55
Fuel tank (radial / vertical lift)	litres	98 / 92	103.3
Engine coolant	litres	10	22
Engine oil min/max.	litres	5.5 / 7.4	12 / 15
LH Chaincase (wheeled machines only)	litres	19	23.3
RH Chaincase (wheeled machines only)	litres	19	23.3

## TRANSMISSION

A full electro-hydraulic controlled hydrostatic transmission giving zero to maximum speed, both forward and reverse at full power. Hydraulic power management system maintains full engine power availability maximising loader and attachment control.

Model		Single Speed	Two Speed
Travel Speeds 155/175/210/215	kmh	12.0	12.0 / 18.5
Travel Speeds 250/270/300/330	kmh	10.9	10.9 / 20.0
Travel Speeds 150T/210T/215T	kmh	10.0	9.0 / 12.5
Travel Speeds 250T/270T/300T/325T/330T	kmh	9.2	7.7 / 12.5

ENGINE				
		SMALL PLATFORM		LARGE PLATFORM
		155/175/150T	210/215/210T/215T	250/270/300/250T/270T/300T/320T/325T
Engine model		Kohler KDI 1903TCR/26B	Kohler - KDI2504TCR/26A	EcoMAX TCAE-55
Displacement	cm <sup>3</sup>	1860	2482	4399
Fuel		Diesel	Diesel	Diesel
Cooling		Liquid	Liquid	Liquid
Aspiration		Turbo	Turbo	Turbo
<b>Gross Power @ 2400 rpm</b>				
SAE J1995	kW (hp)	42 (56)	55 (74)	55 (74)
<b>Gross Torque @ 1200 rpm</b>				
SAE J1995	Nm	225	300	400
Starter motor	kW (hp)	2 (2.72)	2 (2.72)	4.2 (5.63)
Battery	V/Ah	12 / 109	12 / 109	12 / 109
Alternator	amps	100	100	95
Emission certification		EPA-T4F (EU St3B)	EPA-T4F (EU St3B)	EPA-T4F (EU St3B)
Engine oil service interval hours		500	500	500
Variable speed hydraulically driven fan		YES	YES	YES

TYRES / TRACKS	
TYRES	TRACKS
<b>Standard – 155/175/210/215</b> 10 x 16.5 - 8 PR Xtra Wall Off Road	<b>150T/210T/215T</b> 320 mm wide traction lug
<b>Standard – 250/270/300</b> 12 x 16.5 - 10 PR Xtra Wall Off Road	<b>250T/270T/300T/320T/325T</b> 400 mm wide traction lug
<b>Standard – 330</b> 14 x 17.5 - 12 PR Xtra Wall Off Road	<b>Available track options</b> 450 mm wide traction lug
<b>155 / 175 / 210 / 215 Available tyre options</b>	
11 x 16.5 - 10 PR All Terrain	
12 x 16.5 - 10 PR Lifemaster Industrial	
10 x 16.5 - Reinforced 2 Steel Crown, 3 Metal Shoulders Bibsteel All Terrain	
7 x 15 - 14 PR Extra Duty Plus Industrial	
30 x 7.6 - 15 Solid no Aperture Extreme Industrial	
31 x 10 - 18 Solid with Aperture Brawler Heavy Duty Off Road	
33 x 10 - 20 Solid with Aperture Slick Heavy Duty	
<b>250 / 270 / 300 / 330 Available tyre options</b>	
7.6 x 15 Solid Industrial Slick	
11 x 16.5 - 12 PR Xtra Wall Off Road	
12 x 16.5 - 10PR Off Road	
12 x 16.5 - Reinforced 2 Steel Crown, 3 Metal Shoulders Bibsteel All Terrain	
15.5 x 16.5 - 14 PR Off Road Flotation	
33 x 11 - 20 Solid with Aperture Brawler Heavy Duty Off Road	
36 x 22 - 20 Solid with Aperture Brawler Heavy Duty Off Road	
32 x 8.5 - 16 Solid with Aperture Heavy Duty Industrial	
33 x 10 - 20 Solid with Aperture Slick Heavy Duty Off Road	

For arduous conditions and hostile environments solid tyres are recommended.

#### CONTROLS - ALL MODELS

JCB servo control (ISO) pattern provides all drive functions on left and loader function on right joystick. The left hand control pod pivots rearwards, providing unparalleled machine entry/exit.

#### STANDARD EQUIPMENT - ALL MODELS

Isolation mounted canopy. ROPS and FOPS. Restraint activated safety system. Arm rest lap bar safety feature. Centrifugal dry type engine air filter with safety element. Mechanical quick hitch. Electronic hand throttle. Two front and one rear work light. Emergency lower valve. Fuel gauge. Hydraulic park brake. Standard Flow auxiliary hydraulics. Three way joysticks. Rear service access door. Tilting cab. Static seat in wheeled models. Mechanical suspension seat in tracked models. Float. Pod storage area. Cup holder. Power socket. Rear view mirror. Interior light. Battery isolator.

#### OPTIONAL EQUIPMENT - ALL MODELS

Sealed and pressurised cab with heater/defroster. Air conditioning. Mechanical and air suspension seats. Road lights. Beacon. Foot throttle. Fire extinguisher. Toolkit. Self levelling. Level 2 FOPS guard. Heavy-duty rear door guard. Front screen guard. High Flow auxiliary hydraulics. Spark arrester. Tooth guard. Powered quick hitch. Smooth Ride System. Polycarbonate screen. Radio. Twine cutter (wheeled units only). Three inch seat belt. Creep speed. ISO/H pattern changeover. Fenders. Reversing fan. Pre-cleaner.

#### OPERATOR ENVIRONMENT - ALL MODELS

Full ROPS and Level 1 FOPS with optional Level 2 FOPS guard for demolition, full visual and audible warning system. Soundproofing gives noise levels complying with EC regulations. Cab access through side door due to JCB's PowerBoom™ design.

- Deluxe environment available in either open canopy, cab with heat, or cab with heat and A/C.
- Unequaled all-around visibility.
- Fully adjustable seat.
- Retractable seat belt fitted as standard.
- Electric over hydraulic controls with either standard (3 way) joysticks or optional JCB multi-function (7-way) joysticks.

#### LIGHTING AND ELECTRICS

12v Negative ground system  
1,000 cold cranking amp (CCA) battery

**155/175/150T/210/215 /210T/215T** 100 amp alternator and electronic throttle  
**250/270/300/250T/270T/300T/325T** 95 amp alternator

Also incorporated into the instrument panel, is a warning light cluster which also has visual and/or audible alarms for: Low charge pressure, engine water temperature, blocked air filter pressure, engine oil pressure, alternator voltage.

Cab mounted fuse and relay box designed to keep dirt and water out; standard battery disconnect.



**ONE COMPANY, OVER 300 MACHINES.**



Sur la Forêt, 16 - 5340 SOREE (Belgique)  
 +32/83/67.72.33  
 info@monfortsa.be  
 www.monfortsa.be

